

Top view

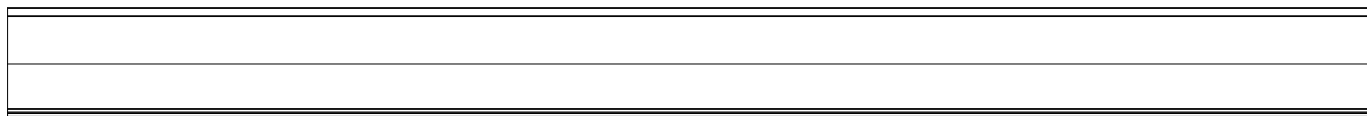

Side view

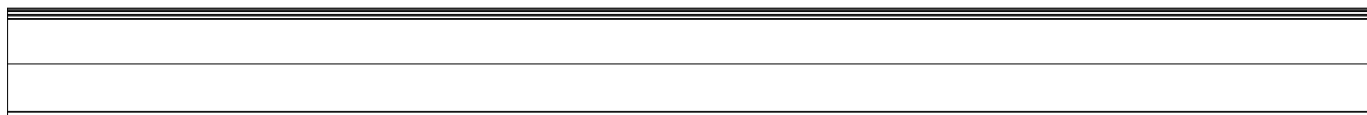

Bottom view



Length max 3020 mm

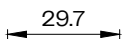

Maximum LED PCB width: 19 mm

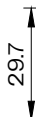
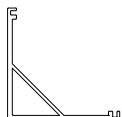

Profile cross section	240 g/m
1000 mm Silver	9711100
2000 mm Silver	9711200
3020 mm Silver	9711300

Disclaimer

Due to the technical evolution and improvement of our products, the data provided in this document may be updated on a regular basis, and as such, confirmation of this information is strongly recommended prior to the order process. OneEightyOne is not responsible for any discrepancies in this document following changes in our products. We reserve the right to make technical changes to our products and to change information, at its sole discretion, without notice.





29.7

Corner diffuser 66 g/m
3020 mm Opal diffused matte
9721320

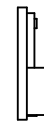
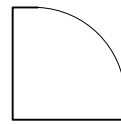

Corner endcap 1 g
Silver 9771900

33.6



20

Mounting clip 1 g
9780990

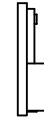
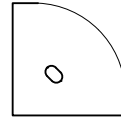

Corner endcap cable entry 1 g
Silver 9771901

2.4

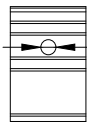
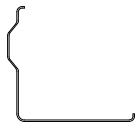

Ø4

Disclaimer

Due to the technical evolution and improvement of our products, the data provided in this document may be updated on a regular basis, and as such, confirmation of this information is strongly recommended prior to the order process. OneEightyOne is not responsible for any discrepancies in this document following changes in our products. We reserve the right to make technical changes to our products and to change information, at its sole discretion, without notice.



Direct Mounting

Mounting clip
Set contains:
2 Mounting clips
2 Woodscrews
($\varnothing 3.5 \times 15.5$)

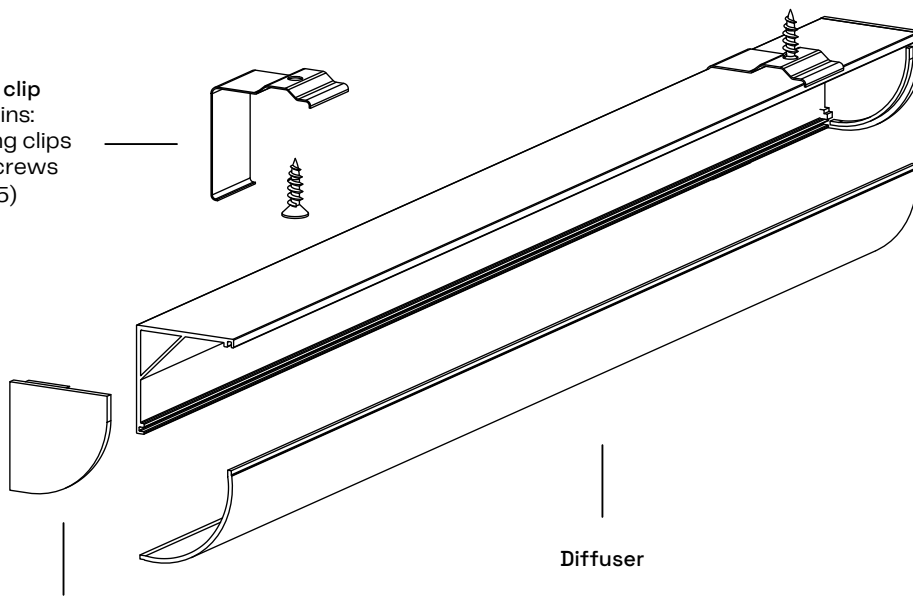

Endcap
Set contains:
2 Endcaps

Disclaimer

Due to the technical evolution and improvement of our products, the data provided in this document may be updated on a regular basis, and as such, confirmation of this information is strongly recommended prior to the order process. OneEightyOne is not responsible for any discrepancies in this document following changes in our products. We reserve the right to make technical changes to our products and to change information, at its sole discretion, without notice.