

Intelligent LED Driver (Constant Voltage)

- The housing is made of V0 flame-retardant PC material, sourced from SAMSUNG/COVESTRO.
- The clamshell design and screwless type for strain-relief. The design of dismountable end cap allows you to adjust the length of housing depending on your needs.
- DMX address, dimming curve, and brightness range can be set via NFC using the mobile app.
- Support the RDM remote Device Management Protocol.
- Provides two-channel independent SELV outputs.
- Supports DMX512/RDM, Push DIM and corridor light DIM.
- Constant power design ensures consistent brightness across color temperature adjustments. Supports deep dimming from 0~100%, with a minimum dimming level of 0.01%.
- It is equipped with a soft-start gradually brightening function, making the visual experience more comfortable for the human eye.
- High-efficiency driver with 93% efficiency, power factor > 0.98, and THD < 6%.
- In compliance with the EU ERP Energy Efficiency Directive, with network standby power consumption below 0.5W.
- Innovative thermal management technology intelligently protects the life of the LED driver.
- Includes protections against overheating, overload, short circuit, and open circuit.
- Suitable for Class I/II indoor light fixtures.
- Designed for a service life exceeding 100,000 hours under normal operating conditions.
- 5-year warranty (Rubycon capacitor).



Flicker-Free
IEEE 1789
Achieve the exemption level.

Dimmable:
1:10000



The certification icon represents undergoing certification applications only, and final certification qualification subject to actual product

Technical Specs

Model	LM-150-24-G1M2F		LM-150-12-G1M2F	
Features	Output Type	Constant Voltage		
	Dimming Interface	DMX512/RDM, Push DIM		
	Output Feature	Isolation		
	Protection Grade	IP20		
	Insulation Grade	Class II (Suitable for class I /II/III light fixtures)		
OUTPUT	Output Voltage	24V $\overline{\text{m}}$	12V $\overline{\text{m}}$	
	Output Voltage Range	24V \pm 0.5V $\overline{\text{m}}$	12V \pm 0.5V $\overline{\text{m}}$	
	Output Current	Max. 6.25A	Max. 12.5A	
	Output Power	Max. 150W		
	Output Power Range	0~150W		
	Strobe Level	High frequency exemption level		
	Dimming Range	0~100%, down to 0.01%		
	Overload Power Limitation	\geq 102%		
	Ripple	Switch ripple \leq 200mV, noise \leq 500mV	Switch ripple \leq 200mV, noise \leq 800mV	
	PWM Frequency	300-22000Hz		
INPUT	AC Voltage Range	220-240V~		
	DC Voltage Range	220-240V $\overline{\text{m}}$ (EMI needs to be evaluated after the luminaire is installed)		
	Frequency	50/60Hz		
	Input Current	Max. 0.75A/230V~		
	Power Factor	PF>0.98/230V~ (at full load)		
	THD	THD<6%@ 230V~ (at full load)		
	Efficiency (Typ.)	93%	92%	
	Standby Power Loss	< 0.5W		
	Inrush Current	Cold start 45.6A(Test twidth=500us tested under 50% Ipeak)/230V~		
	Anti Surge	L-N: 2KV		
Leakage Current	Max. 0.5mA			
ENVIRONMENT	Working Temperature	ta: -20 ~ 50°C tc: 85°C		
	Working Humidity	20 ~ 95%RH, non-condensing		
	Storage Temperature/Humidity	-40 ~ 80°C, 10~95%RH		
	Temperature Coefficient	\pm 0.03%/°C(0-50°C)		
	Vibration	10~500Hz, 2G 12min/1cycle, 72 min for X, Y and Z axes respectively		
PROTECTION	Overload Protection	Shut down the output when rated power \geq 102%, auto recovers		
	Overheat Protection	Intelligently adjust or turn off the output current if the PCB temperature \geq 110°C, and recover automatically		
	Short Circuit Protection	Enter hiccup mode if short circuit occurs, and recover automatically		
	Overvoltage Protection	Shut down the output when no-load voltage \geq 28V, and recover automatically	Shut down the output when no-load voltage \geq 16V, and recover automatically	
SAFETY & EMC	Withstand Voltage	I/P-O/P: 3750V~		
	Insulation Resistance	I/P-O/P: 100M Ω /500VDC/25°C/70%RH		
	SafetyStandards	CCC	China	GB19510.1, GB19510.14, GB19510.213
		TUV	Germany	EN61347-1, EN61347-2-13, EN62493
		CB	CB MEMBER STATES	IEC61347-1, IEC61347-2-13
		CE	European Union	EN61347-1, EN61347-2-13, EN62384
		KC	Korea	KC61347-1, KC61347-2-13
		EAC	Russia	IEC61347-1, IEC61347-2-13
		RCM	Australia	AS 61347-1, AS 61347-2-13
		ENEC	Europe	EN61347-1, EN61347-2-13, EN62384
		BIS	India	EN61347-1, EN61347-2-13, EN62384
	EMC Emission	CCC	China	GB/T17743, GB17625.1
		CE	European Union	EN55015, EN61000-3-2, EN61000-3-3, EN61547
		KC	Korea	KN15, KN61547
		EAC	Russia	IEC62493, IEC61547, EH55015
RCM		Australia	EN55015, EN61000-3-2, EN61000-3-3, EN61547	
ErP	Power Consumption	Networked standby	< 0.5W(After shutdown by command)	
		No-load power consumption	No no-load mode	
	Flicker/Stroboscopic Effect	IEEE1789	Meet IEEE 1789 standard/High frequency exemption level	
		CIE SVM	PstLM \leq 1.0, SVM \leq 0.4	
	DF	Phase factor	DF \geq 0.9	
OTHERS	Weight(N.W.)	430g \pm 10g		
	Dimensions	352 \times 43 \times 30mm(L \times W \times H)		

This driver is suitable for connecting to resistor-limited LED fixtures (e.g., LED strips). If connected to fixtures with built-in constant-current ICs, it may generate instantaneous surge currents dozens of times higher, triggering overload protection (hiccup-mode flickering). For such fixtures (e.g., MR16 bulbs, buried lights, wall washers, constant-current rigid strips), please specify during ordering to enable firmware reprogramming.

Product Size

Unit: mm

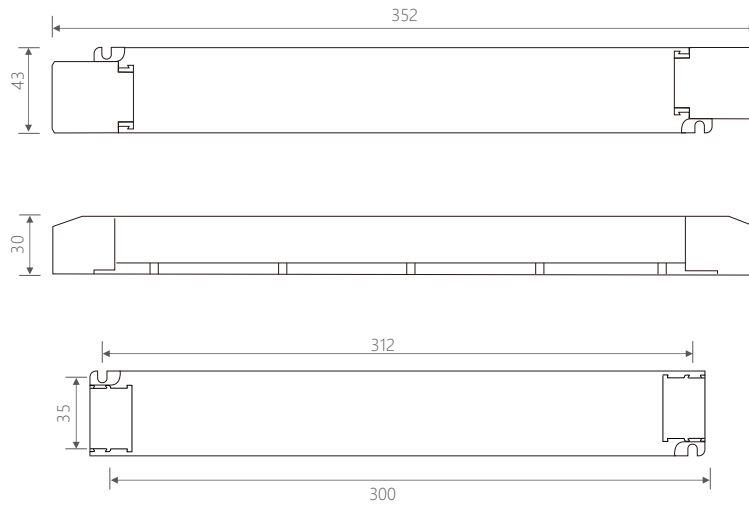

Wiring Diagram

DMX512/RDM Connection

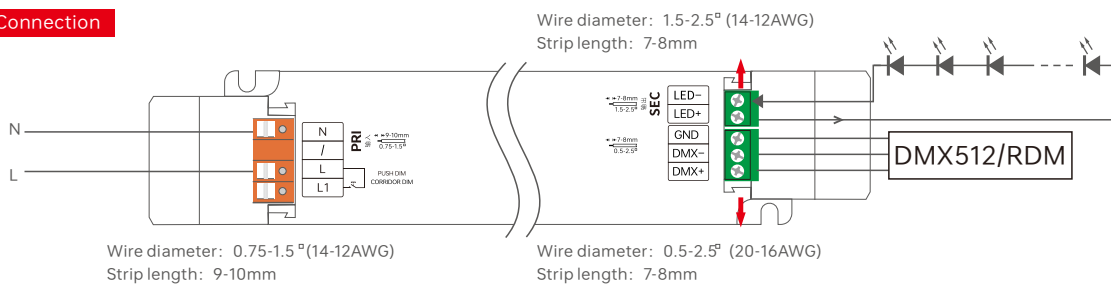

Push DIM Connection

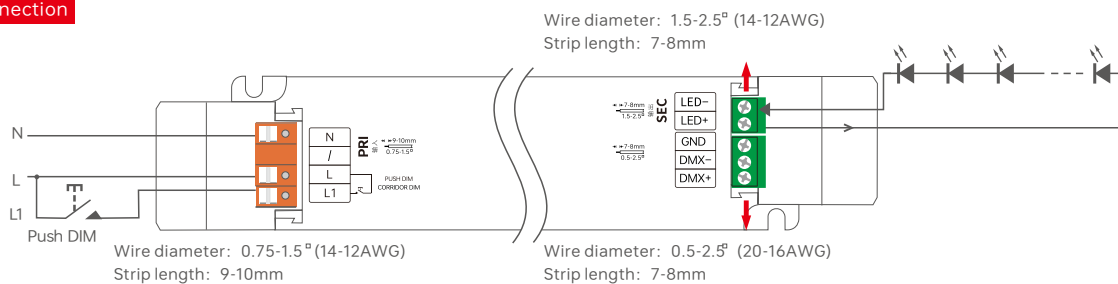

*Dimming interface priority: DMX512/RDM first, Push DIM next.
Only when the system failure status setting is set to "Memory" and no DMX data is received, it can be allowed to switch to PUSH DIM.
*The system failure status can be set through NFC lighting/WiFi-RDM.

Switch to PUSH DIM Mode:

Method 1: If it has been switched to the corridor dimming mode, connect the wires according to the Push DIM wiring diagram. Press the switch briefly 5 times within 3 seconds of reset button, then press and hold it for 6 seconds, and then press it briefly 5 times within 3 seconds. The driver will automatically switch to the Push DIM dimming mode.

Method 2: If it is switched to the corridor mode, you can switch to the Push DIM dimming mode through the NFC Lighting app.

Push DIM



Reset Switch

Short press : on/off control.

Double-click: Not available.

Long press : Adjust the current brightness.

Dimming memory : When the light is switched on/off again, the light will resumes to the previously set brightness level.

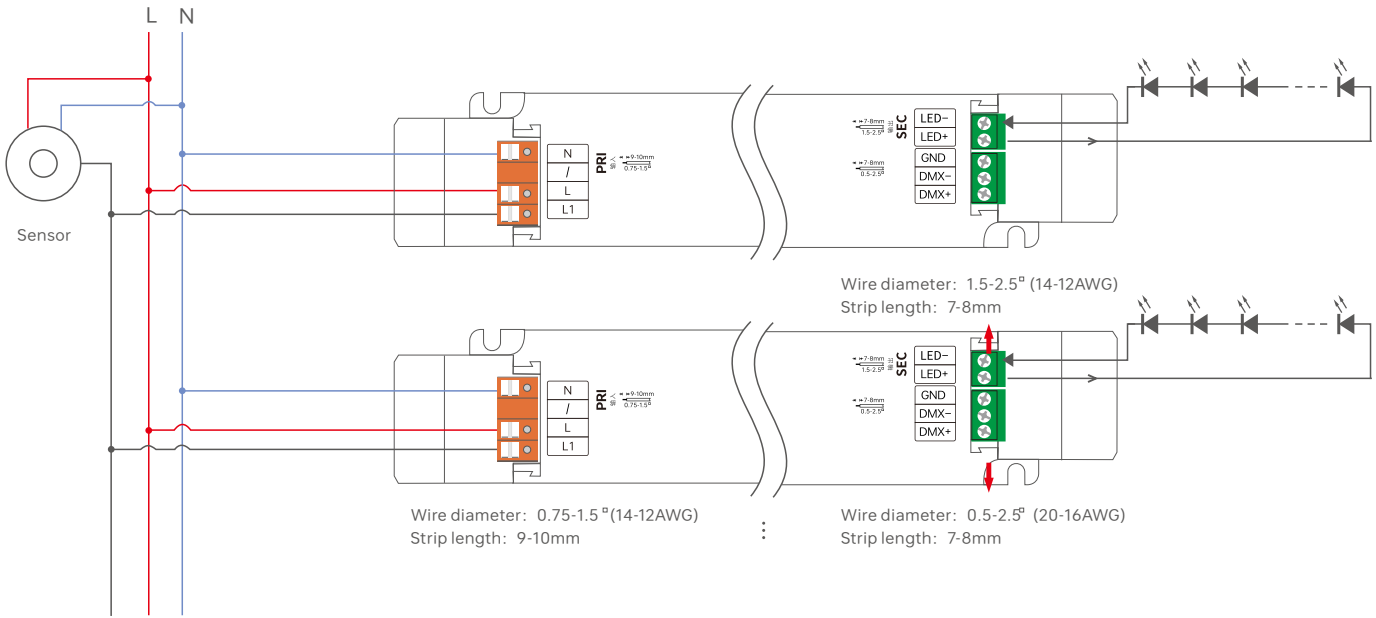

Switch to the corridor light mode

Method 1: Configure and switch the corridor light function via NFC, and the Push DIM function will be turned off.

Method 2: After connecting the wires according to the corridor dimming wiring diagram, keep moving within the effective sensing area for more than 2 minutes, and it will automatically switch to the corridor dimming mode with all lights on at full brightness.

Method 3: After connecting the wires according to the corridor dimming wiring diagram, first replace the sensor with a common switch, then turn on the common switch and keep it conducting for 2 minutes. The driver will automatically switch to the corridor dimming mode. After that, remove the common switch and replace it with the sensor again.

Note: During normal operation, it is recommended to set the hold-time of the motion sensor to the minimum.

It is necessary to select a motion sensor with an AC switch.

Corridor Dimming: Working Process

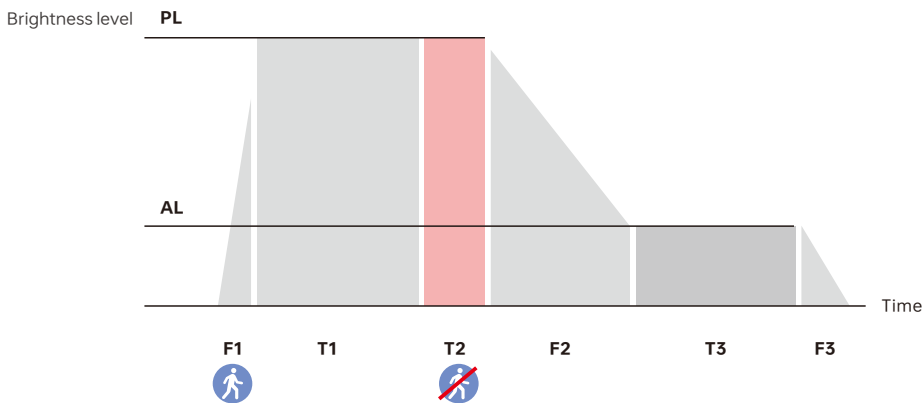

Name	Default	Setting Range
(F1) Gradual Entry Sensing Time	1 s	0-100 s
(PL) Sensing Brightness	255	0-255
(T1) Sensing Holding Time	Set through the sensor	
(T2) Delay Time	30 s	0 s,5 s,10 s,20 s,30 s,45 s,1 min, 2 min, 3 min,5 min,10 min,20 min,30 min
(F2) Gradual Exit Sensing Time	1 s	0-100 s
(AL) Standby Brightness	100	0-255
(T3) Sensing Standby Time	30 s	0 s,5 s,10 s,20 s,30 s,45 s,1 min,2 mins,3 mins,5 mins, 10 mins,20 mins,30 mins,Permanent
(F3) Gradual Exit to Off Time	1 s	0-100 s

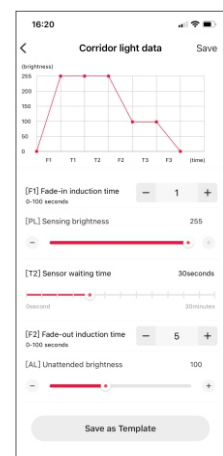

Note: *If the lamp needs to be on standby at a low brightness level, the [T3] Sensing Standby Time should be set to "Permanent".
*The above parameters are set through the NFC lighting APP.

Use with RDM Editor

The DMX driver can work with a DMX address programmer that follows the standard RDM protocol.

It is recommended to use LTECH RDM Programmer (Model: WiFi-RDM01), which can achieve more functions such as remote browsing and parameter setting.

Wiring diagrams below:

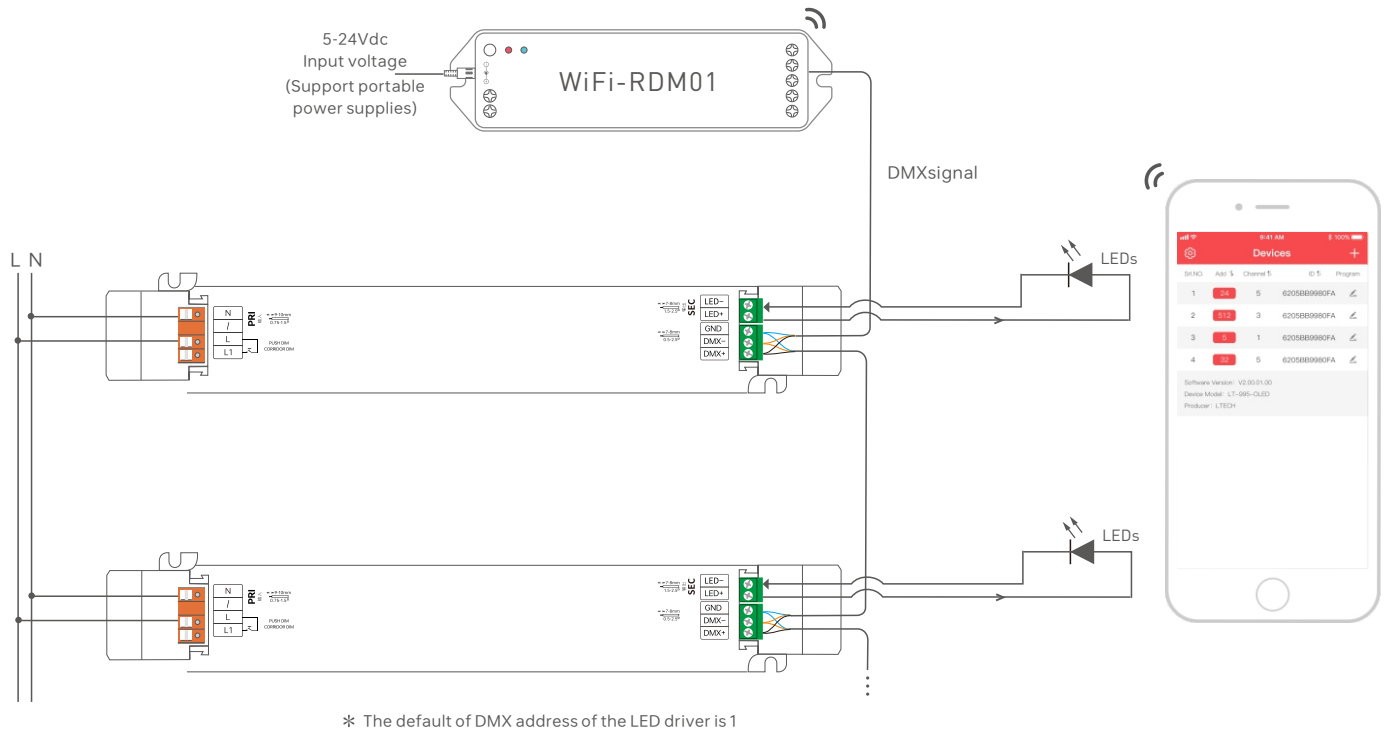

LTECH RDM Programmer APP interface introduction

Download the App with your mobile phone and connect the RDM Programmer successfully, then you are allowed to set parameters through the APP. Please refer to the WiFi-RDM01 manual for more details.

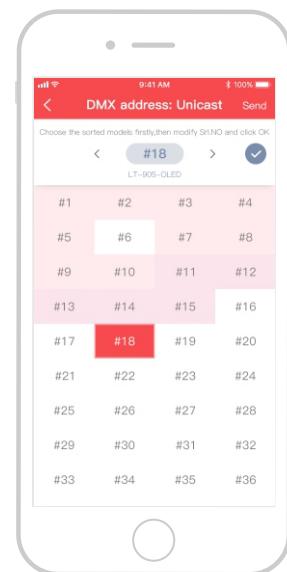
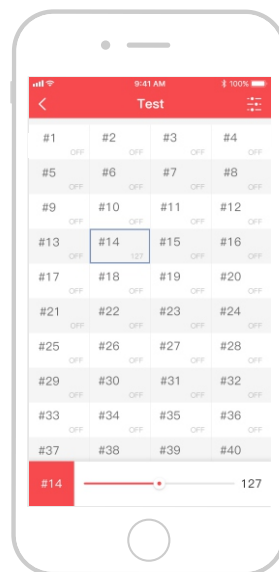
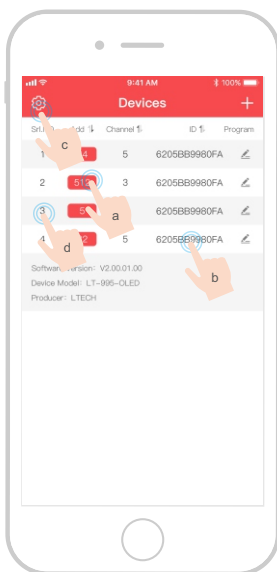

- a : Click "Add", edit the address in corresponding box ;
- b: Click "ID", get more product details ;
- c: Click "⚙️", enter the settings interface
- d: Click "No.", issue the recognizing command.

Testing

DMX address setting

Protective Housing Application Diagram

Tension plate

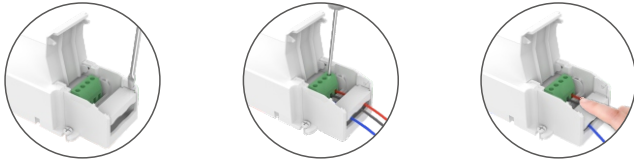

1. Pry up the protecting housing in the side plate position with a tool.
2. Connect to electrical wires with a screwdriver as wiring diagram shows.
3. Press down the tension plate to fix the the electrical wires, then close the protective housing.

Remove the protective housing

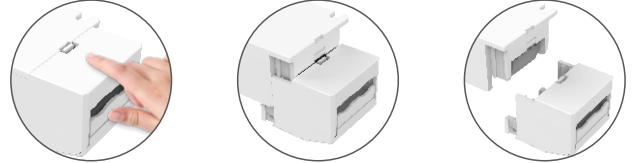

Pull the housing left and right from the bottom to remove it.

Installation Precautions

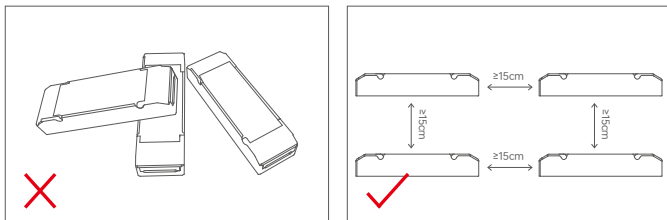

Please do not stack the products. The distance between two products should be $\geq 15\text{cm}$ so as not to affect heat dissipation or the lifetime of the products.

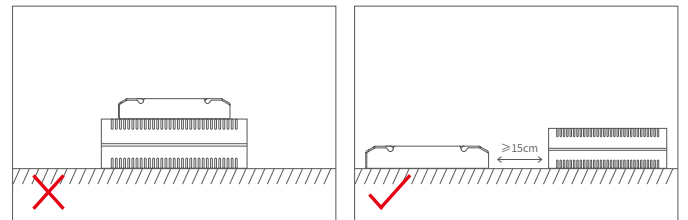

Please not place the products on power supplies. The distance between the product and the power supplies should be $\geq 15\text{cm}$ so as not to affect heat dissipation or shorten the lifetime of the products.

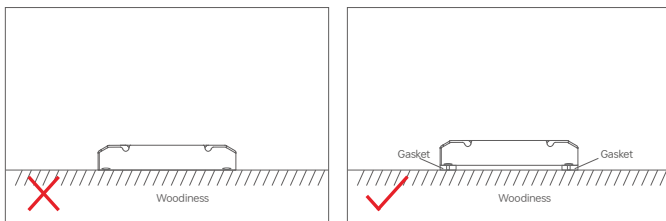

Do not fix the product screws tightly against the wooden board. Instead, add a washer with a thickness of $\geq 7\text{mm}$ under the fixing screws. Leaving some gaps can effectively dissipate heat, preventing any impact on the product's heat dissipation performance and service life.

Use the NFC Lighting APP

Scan the QR code below with your mobile phone and follow the prompts to complete the APP installation (According to performance requirements, you need to use a NFC-capable Android phone, or an iPhone 8 and later that are compatible with iOS 13 or higher).



* Before you begin setting the parameters of the driver, please make sure the driver is powered off.

Read/Write the LED driver

Use your NFC-capable phone to read LED driver data, then edit the parameters and they can be directly written to the driver

1. Read the LED driver

On the APP home page, click [Read/Write LED driver], then keep the programmer's sensing area close to the NFC logo of the driver to read the driver parameters.

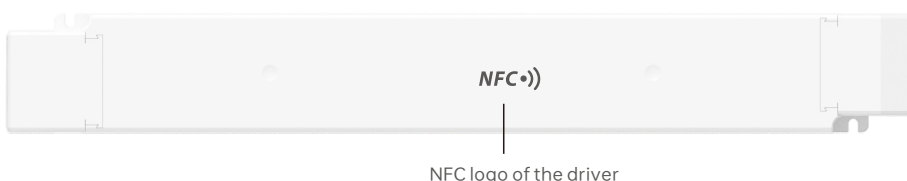

2. Edit parameters

Click on [Parameter Management] to edit more advanced parameters such as DMX Address, Dimming Curve, PWM Frequency, Bit Depth, Brightness Range, Time for Fading to Dim Level, Power-on Status, System Failure Level, and Corridor Lights.

3. Write to the drive

After completing the parameter settings, click [Write] in the upper right corner, and keep the programmer's sensing area close to the NFC logo of the driver, so the parameters can be written to the driver.

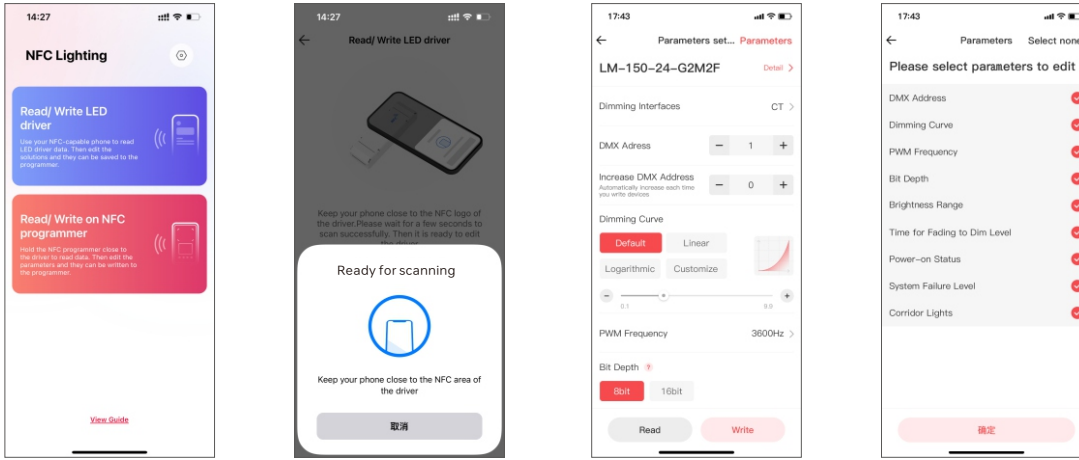

Relationship Diagrams

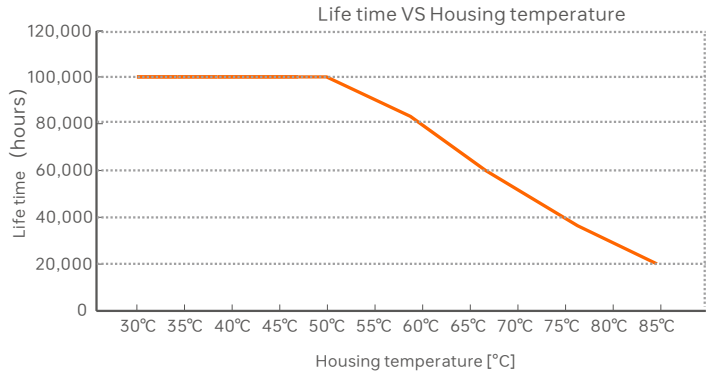
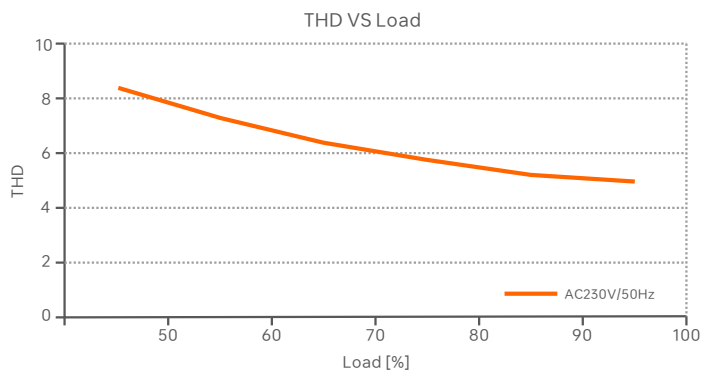
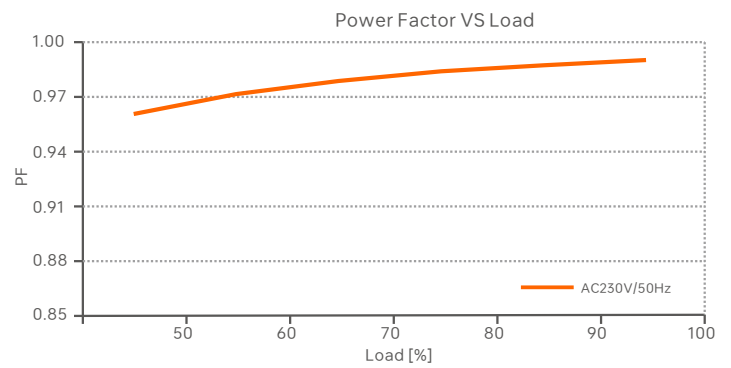
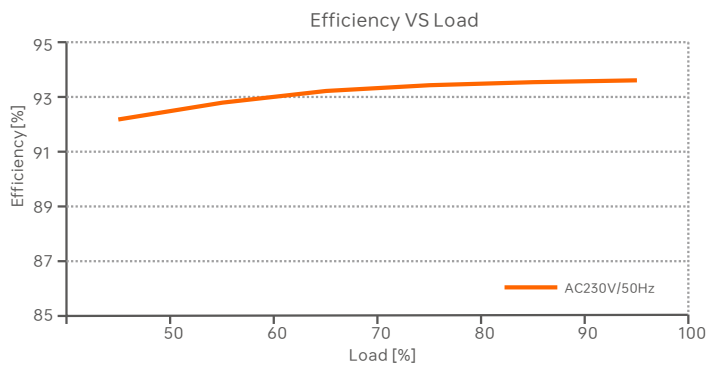

LM-150-24-G1M2F

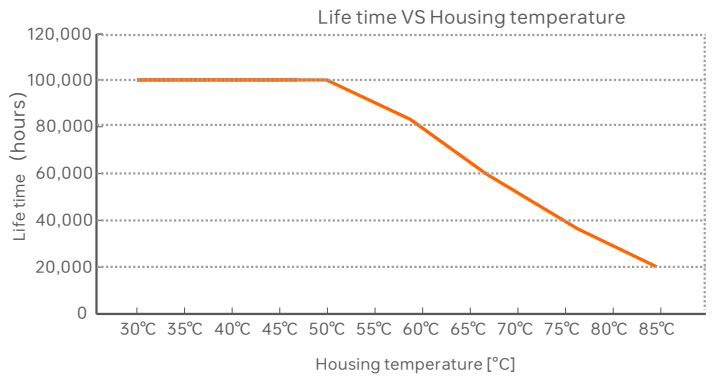
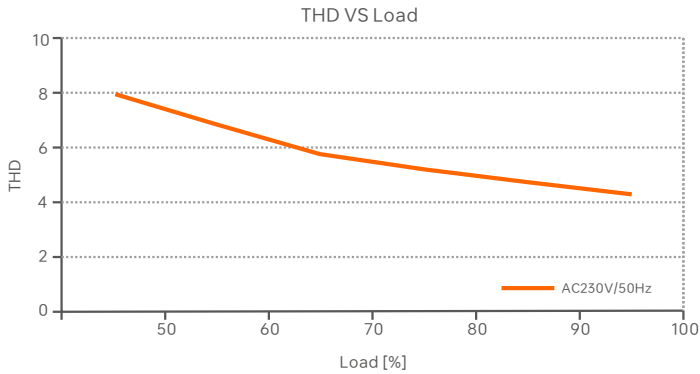
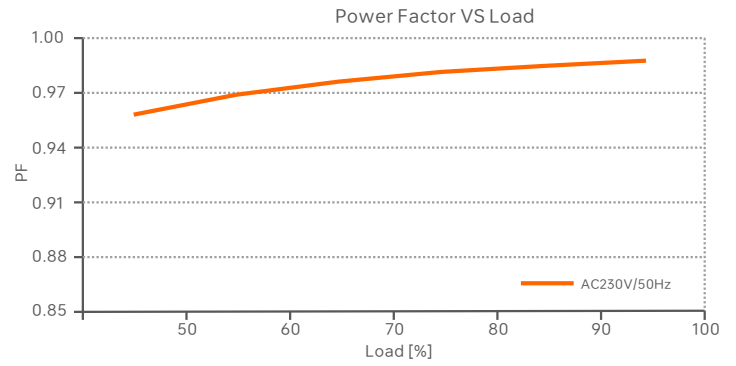
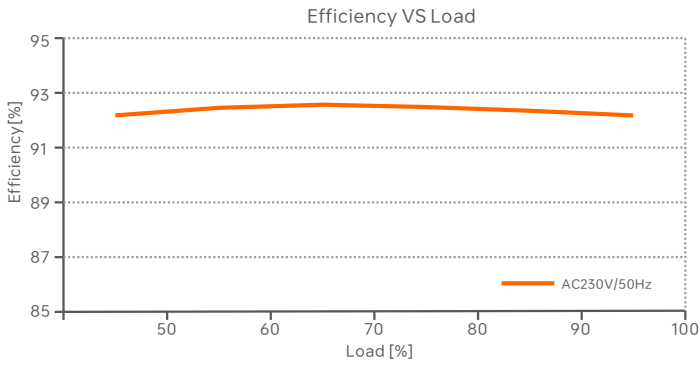

LM-150-12-G1M2F

Surge Current & Corresponding Miniature Circuit Breaker (MCB) Load Capacity Table

MCB Model	B10	B13	B16	B20	B25	C10	C13	C16	C20	C25	D10	D13	D16	D20	D25
Maximum Load Capacity	4	5	6	8	11	7	9	11	14	18	9	11	15	20	26

Remarks:

1. Test Conditions: Cold start 45.6A (Test twidth=500us tested under 50% Ipeak)/230V~
2. The number of supported drivers may vary depending on the brand and model of the MCB.
3. It is recommended not to exceed the specified load capacity during on-site installation. The actual load should be determined based on field conditions.
4. If the ambient temperature exceeds 30°C or multiple MCBs are installed side by side, the number of installed drivers must be reduced and recalculated accordingly.
5. Electricians typically use Type B MCBs for residential lighting and Type C MCBs for commercial lighting applications.
6. Different testing equipment may yield variations in measured current peaks and pulse widths. Always use professional-grade instruments for accurate testing.

Flicker Test Table

Limit Value of Modulation in Low Risk Areas	
Waveform frequency of Optical output (f)	Limit value (%)
f ≤ 8Hz	0.2
8Hz < f ≤ 90Hz	0.025 × f
90Hz < f ≤ 1250Hz	0.08 × f
f > 1250Hz	Exemption assessment
Limit Value of Modulation in No Effect Areas	
Waveform frequency of Optical output (f)	Limit value (%)
f ≤ 10Hz	0.1
10Hz < f ≤ 90Hz	0.01 × f
90Hz < f ≤ 3125Hz	(0.08/2.5) × f
f > 3125Hz	Exemption assessment (High frequency exemption)

Brightness

- ▲ 0.1%
- ◆ 1%
- ▲ 5%
- ◆ 10%
- 20%
- ▲ 30%
- 40%
- 50%
- 60%
- 70%
- 80%
- ★ 90%
- ◆ 100%

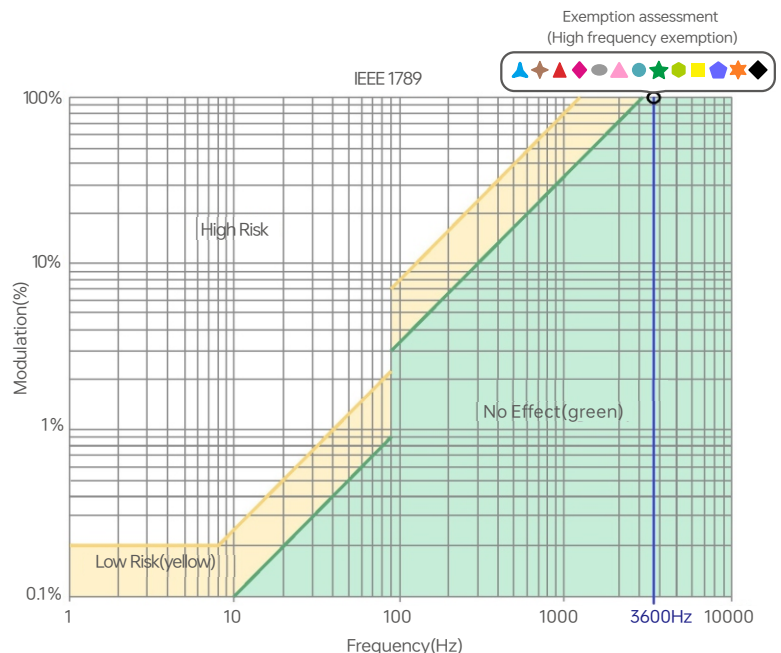

Marks in the right chart are tested results of different current levels. The output frequency is 0Hz in 100% brightness and its corresponding modulation is 0%, which could not be shown in the right chart.

Packaging specification

Model	LM-150-24-G1M2F、LM-150-12-G1M2F
Packaging box size	370×340×93mm(L×W×H)
Quantity	10PCS per layer 2 layers per box 20PCS per box
Weight	0.43kg/PC;9.4kg±5%/box

Packaging style drawing

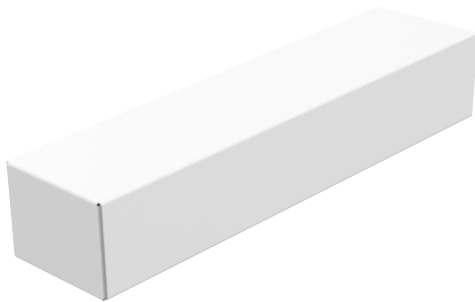

Inner packaging box



Full box packaging

Transportation and Storage

1. Transportation

Products can be shipped via vehicles, boats and planes.

During transportation, products should be protected from rain and sun. Please avoid severe shock and vibration during the loading and unloading process.

2. Storage

The storage conditions should comply with the Class I Environmental Standards. The products that have been stored for more than six months are recommended to be re-inspected and can be used only after they have been qualified.

Attentions

- Product installation and commissioning should be done by a qualified professional.
- LTECH products are and not lightningproof non-waterproof (special models excepted). Please avoid the sun and rain. When installed outdoors, please ensure they are mounted in a water proof enclosure or in an area equipped with lightning protection devices.
- Good heat dissipation will prolong the working life of products. Please ensure good ventilation.
- Please check if the working voltage used complies with the parameter requirements of products.
- The diameter of wire used must be able to load the light fixtures you connect and ensure the firm wiring.
- Before you power on products, please make sure all the wiring is correct in case of incorrect connection that causes damage to light fixtures.
- If a fault occurs, please do not attempt to fix products by yourself. If you have any question, please contact your suppliers.
- * This manual is subject to changes without further notice. Product functions depend on the goods. Please feel free to contact our official distributors if you have any question.

Warranty Agreement

- Warranty periods from the date of delivery: 5 years.
- Free repair or replacement services for quality problems are provided within warranty periods.

Warranty exclusions below:

- Beyond warranty periods.
 - Any artificial damage caused by high voltage, overload, or improper operations.
 - Products with severe physical damage.
 - Damage caused by natural disasters and force majeure.
 - Warranty labels and barcodes have been damaged.
 - No any contract signed by LTECH.
1. Repair or replacement provided is the only remedy for customers. LTECH is not liable for any incidental or consequential damage unless it is within the law.
 2. LTECH has the right to amend or adjust the terms of this warranty, and release in written form shall prevail.

Update Log

Version	Updated Time	Update Content	Updated by
A0	2025.06.06	Original version	Li Haipeng